

MODEL NO:
VF42024WB
VF42024CG
VF42024WH

ELEGANT
FURNITURE & LIGHTING™

500-550 E. Erie Avenue
Philadelphia PA 19134
1-888-388-3390

PROJECT:

SPEC NO:

MODEL NO:VF42024

QUANTITY:

DRAWING APPROVAL STATUS

- APPROVED
- APPROVED AS NOTED
- NOT APPROVED, REVISE AS NOTED

AUTHORIZED SIGNATURE

DATE:

FOR PROPOSAL ONLY. ALL DIMENSIONS TO BE VERIFIED

Drawing Date:2019-5-7

REVISIONS

△1	
△2	
△3	
△4	
△5	

DWG. NO.

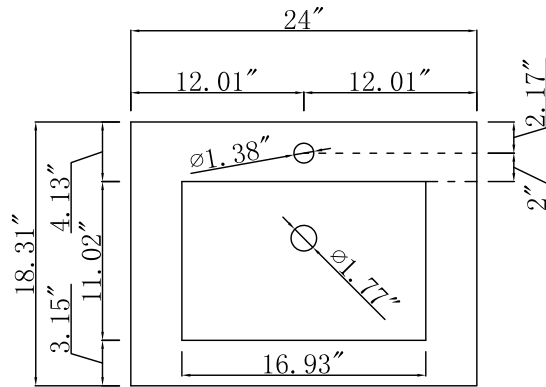

Top view



Length:7"

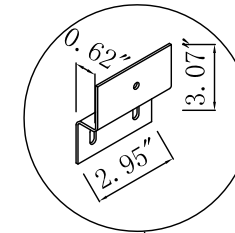

Metal bracket

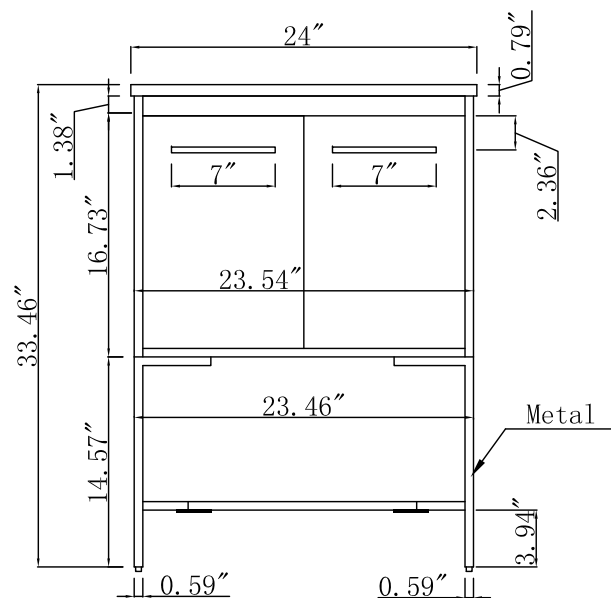

Front view

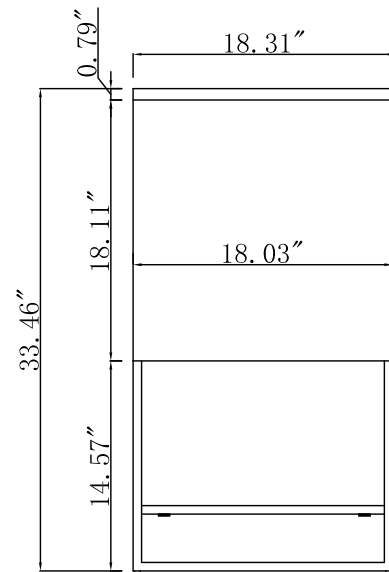

Side view

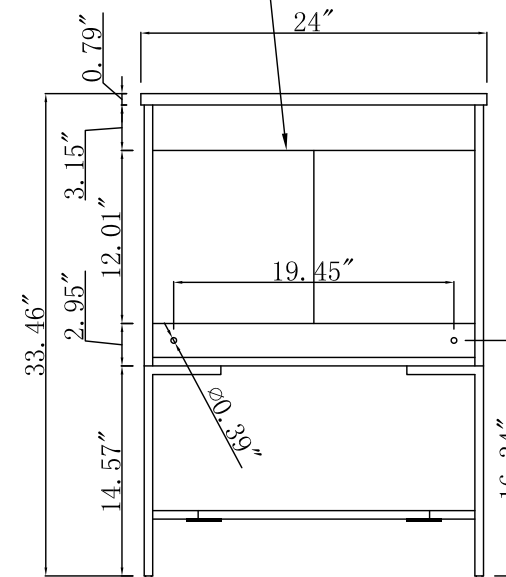

Back view

Model #	VF42024WH	"Number of Doors "	2	"Table: seating capacity"	1	"drawer glide extension"	N/A	"cabinet interior width"	22.36"
Finish	White	"Finished Back "	NO	"upholstery color"	N/A	"drawer glide material"	N/A	"cabinet interior depth"	16.85"
"Hand Painted"	NO	"Hardware finish "	Black	"upholstery pattern"	N/A	"drawer dividers"	N/A	"leg height"	14.57"
"Mirror type"	N/A	"Assembly "	YES	"cushion material"	N/A	"Drawer Interior finish"	N/A	"leg width"	23.46"
"Beveled glass"	N/A	"Product Width "	24"	"base finish"	White	"Ball Bearing Glides"	N/A	"leg depth"	17.83"
"Frame material "	MDF	"Product Depth"	18.31"	"powder coated finish"	YES	"soft close drawer glides"	N/A	"gloss finish"	NO
"Solid wood construction "	N/A	"Product Height"	33.46"	"base material"	MDF	"Number of cabinets"	1	"stackable"	NO
"Drawers Included "	NO	"Package LENGTH"	28.3"	"top material"	Porcelain	"shelf height"	3.94"	"leg design"	Bracket legs
"Number of Drawers"	N/A	"Packaged WIDTH"	25.6"	"wood species"	MDF	"shelf width"	15.94"	"Armoires: ring slots"	N/A
"Joinery Type "	N/A	"Packaged HEIGHT"	25.2"	"tip over restraint strap "	N/A	"shelf depth"	17.83"	"Armoires: hooks"	N/A
"Drawer railing "	N/A	"Package Weight(lbs) "	71	"shape of top"	Rectangle	"Shelf thickness"	0.59"	"armoires: mirror dimensions "	N/A
"Drawer Width"	N/A	"Product Weight(lbs)"	66	"lift top"	NO	"Any certification?" (CARB/TSCA VI)	YES	"door thickness"	0.59"
"Drawer Depth "	N/A	"Shipping Type"	Small Parcel	"shelf material"	MDF	"California Proposition 65 warning required"	YES	"false drawers?"	N/A
"Drawer Height "	N/A	"table top width"	18.31"	"adjustable shelves"	NO	"Drawers Interior Height"	N/A	"sink type "	Porcelain
"Shelves "	YES	"table top finish"	White	"Drawer Handle designs"	Bar Pulls	"Drawer Interior Width"	N/A	"# of faucet holes "	1
"Number of Shelves "	1	"glass top tempered"	NO	"saftey stop"	YES	"Drawer Interior Depth"	N/A		
"Doors included "	YES	"table top maximum weight "	66 LBS	"felt lined drawers"	N/A	"cabinet interior height"	17.52		

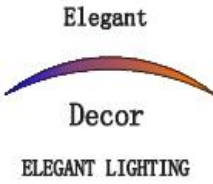
DWG. NO.:	
MODEL NO.:	
ALTERATIONS	
①	
②	
③	
④	
FOR PROPOSAL ONLY ALL DIMENSIONS TO BE VERIFIED	
SCALE:	
DWG. BY:	
CHECKED BY:	
DATE:	
PROJECT:	
Qty:	
Color:	
DRAWING TITLE:	
FINISH:	
 <p>Elegant Decor ELEGANT LIGHTING</p>	